

Varenummer: 40600700752455
 Beskrivelse: Tandhjulsgeær C702F-7,5-P160B5

Mål

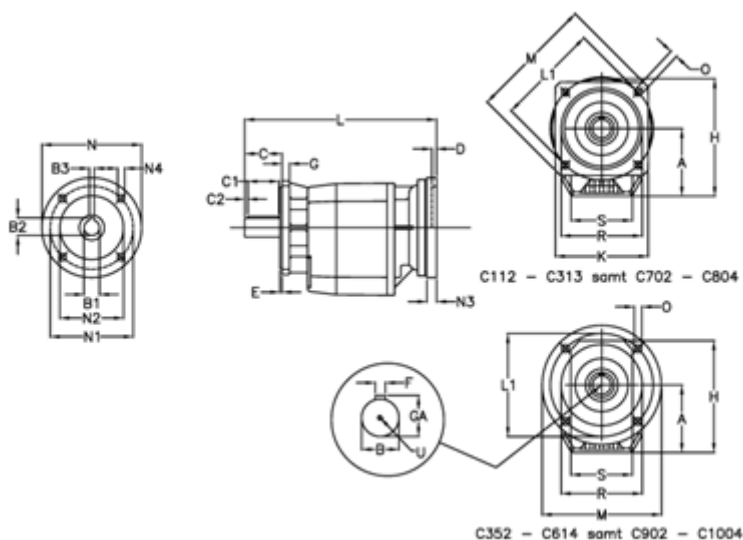

A = 208.0	D = 6.0	L1 = 300	R = 262
B = 60	E = 5	M = 350	S = 250
B1 = 42	F = 18	N = 350	U = M20x42
B2 = 45.3	G = 17	N1 = 300	
B3 = 12	GA = 64.0	N2 = 250	
C = 120	H = 358.0	N3 = 23	
C1 = 90	K = 300	N4 = 18	
C2 = 15	L = 575.0	O = 18.0	